



Engineering Solutions



AUTOMOTIVE | ELECTRONICS | MEDICAL

S.R. ENGINEERING SOLUTIONS started in 2012 and our company has supplying finished products to various industries Automotive, Electronics and Medical.

We have grown from strength to strength by producing customer's specification precisely.

Our team to meet the challenging and changing needs of the customer. We are well equipped with Injection Molding machines, Conventional machines, CNC milling machine, Laser Cutting & Folding and dedicated team of highly skilled professional to meet the production schedules.

VISION:

To develop an Origination which caters Engineering Solutions for Various Requirements of
- Valued Customers.

CORE VALUES:

- To meet the customers demands by Providing a optimal and cost-effective solutions with on time.
- Ensure customer delight through on time delivery.
- Provide the safe and pleasant work environment for all our Employees.

CORE COMPETENCE:

- Manufacture of all types of injection molding component,
Sheetmetal Enclosers and Auto spare components with competitive price
- Design and Development of Jig & Fixtures, Injection Moulds and Tools.
- Design and development of manufacturing layout with lean principles.
- Fabrication of worktables and Material handling Equipment's.



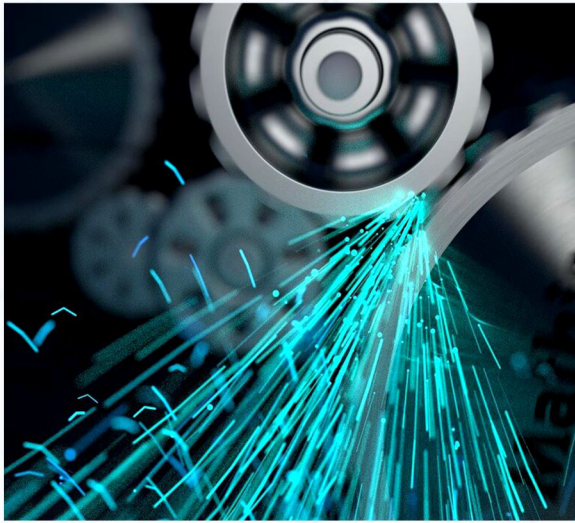

FACILITY & ASSOCIATED FACILITY :

- VMC- Vertical Machining Centre – 3 machine
- CNC Turning Machining Center – 5 Machine
- CMM Inspection machine - 1 machine
 - Make – TMT, Model - Plano - 454. Software - CMM manager
- CNC Press braking (folding) – Denner – 1 Machine
 - 5 Axes machine
 - MAX 6MM for 3Meter, Max 10mm for 1.5 Meter
 - Tonnage : 175 tone
- Automated Injection molding machine – 2 machines
 - SSBT - 90 Ton
 - SSBT - 120 Ton

INFRASTRUCTURE:

- Design Center:
Plot : 4, Dhanalakshmi Enclave, Noombal, Chennai 600 077.
- Branch Office:
No.145, Tiny Sector, Sidco Industrial Estate,
Korattur, Chennai - 600 098.
- Branch Office:
No.234, CNS Street, Newtown, Vaniyambadi,
Vellore Dt, - 635 751.
- Organization:
25 to 30 Peoples

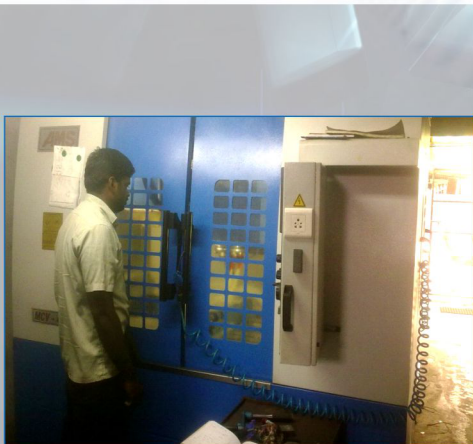

JIGS & FIXTURES, INSPECTION JIGS AND PUNCH & DIES

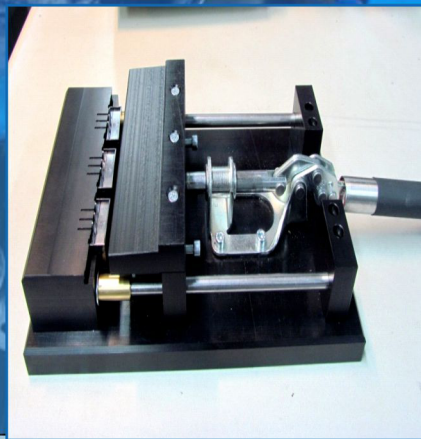
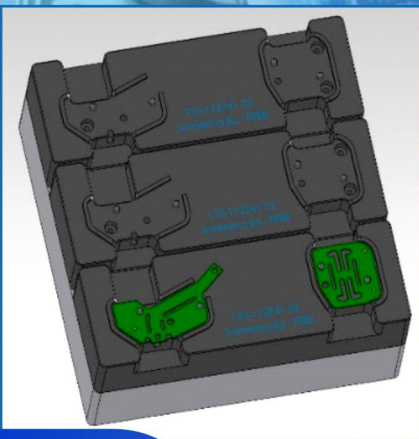
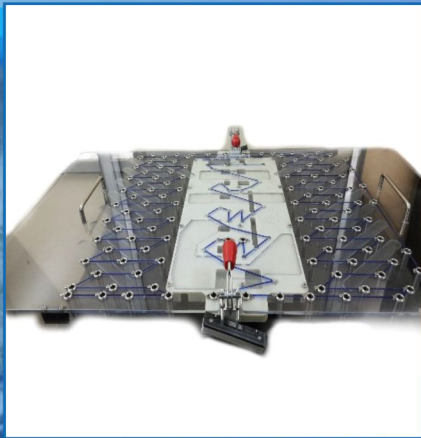
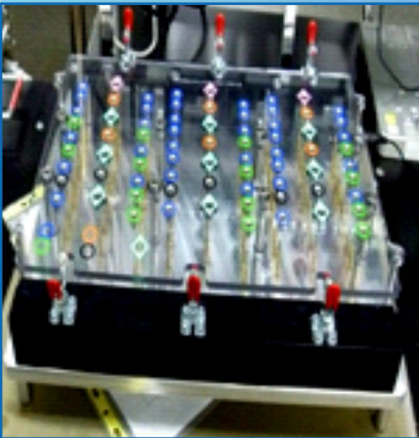
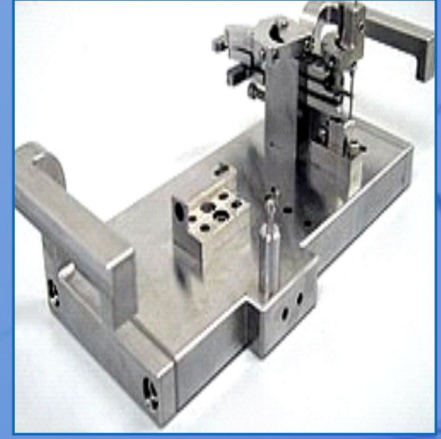
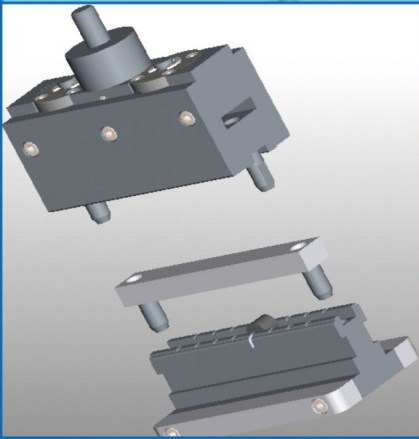

FABRICATION - TABLES AND TROLLEYS



FABRICATION - TABLES AND TOOLS



Torx Bits



Socket Adapters



Sockets and wrenches



Impact sockets



Cup Brushes



Clamps, ESD Wheels
Pipe & joints, Roller tracks,

MATERIAL HANDLING EQUIPMENT



Work Positioners



Work Positioners

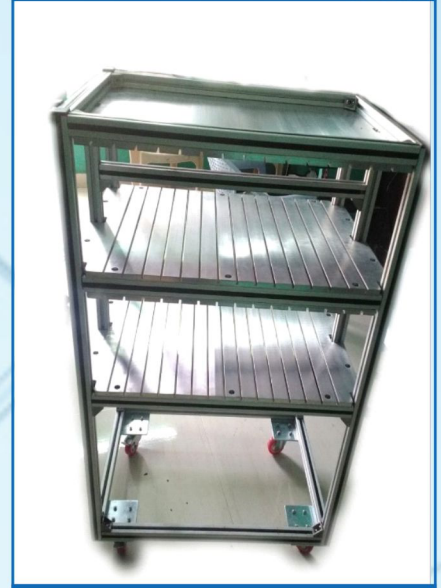

Material Handling Trolleys

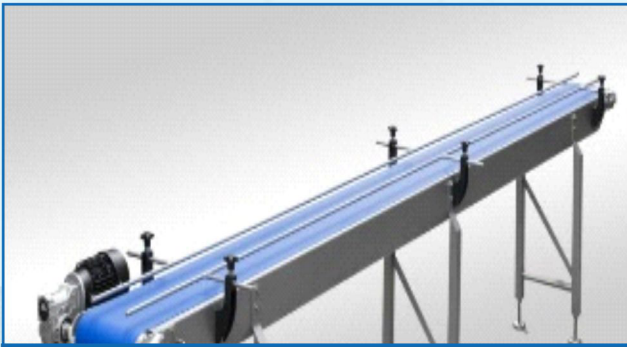

Belt Conveyor



Conveyors With Work Table

We excellence
in Delivery & Quality Standard



ESD PRODUCTS



ESD Top Fit Gloves



ESD Nitrile Gloves



ESD Palm Fit Gloves



ESD Finger Cots



ESD Clean Room Wipes

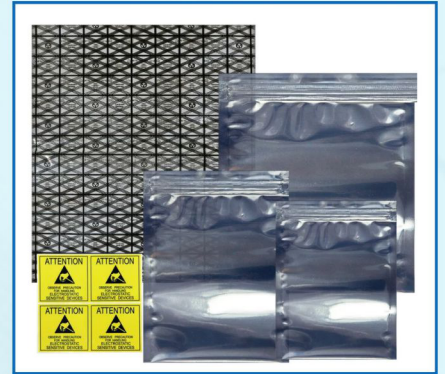

Antistatic Bags

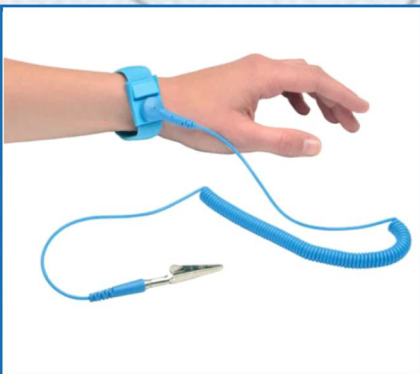

ESD Wrist Strap

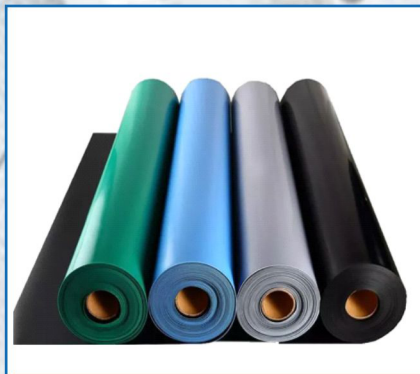

Anti Static Rubber Mat



ESD Cleaning Swap



Penguin Safety Knife

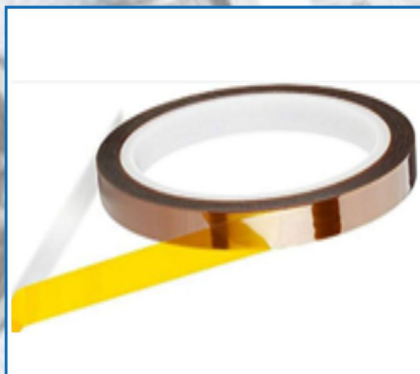

Kapton Tape



Karam Safety Goggles

Products

ESD PRODUCTS



Shoe Covers



Tweezer



ESD Bins

OTHER PRODUCTS



Stationery Items



All Type Of Markers



Floor Marking Tape

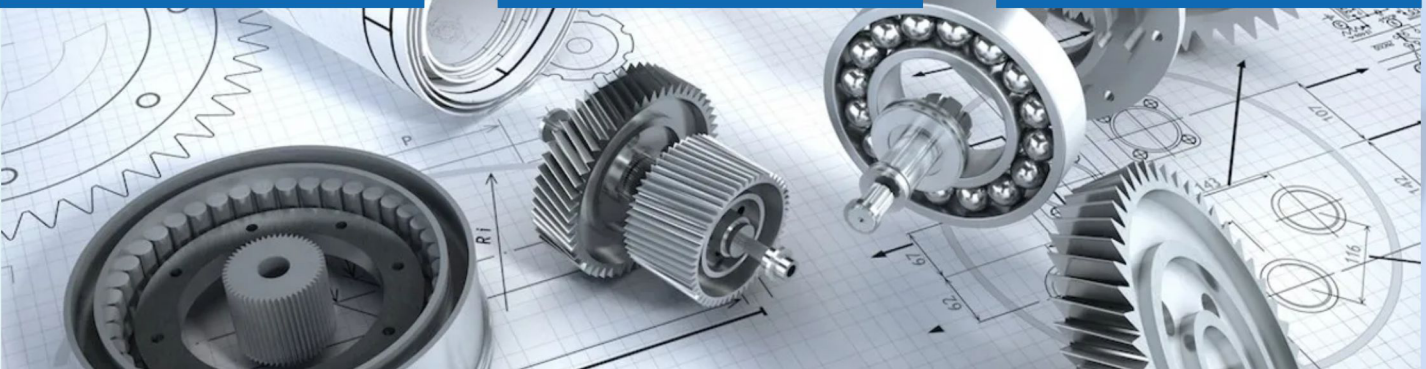

**Premium Quality
&
Standard**



Our Valuable Clients



THANK YOU

**Best Commitment
We Serve**

design@nscon.in



For More Details:

www.srengsolutions.com



Engineering Solutions



Design Center: Plot No:4, Dhanalakshmi Enclave, Noombal, Chennai - 77.

Branch Office: 145, Tiny Sector, SIDCO Industrial Estate, Korattur, Chennai. - 98.

Branch Office: 234, CNS Street, Newtown, Vaniyambadi, Vellore Dt, - 635751.



+91 8939079631



srenggsolutions@yahoo.com

sales@srengsolutions.com